

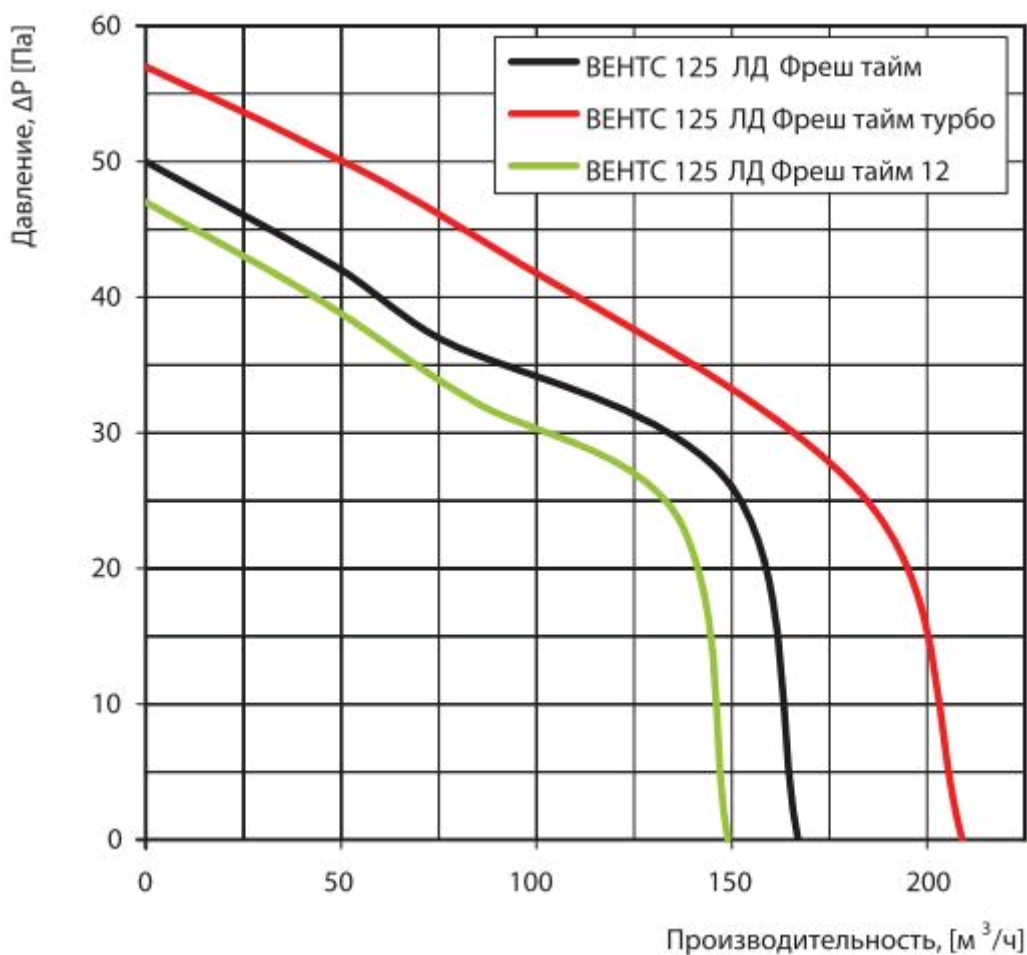





































































Технические характеристики ВЕНТС 125 ЛД Фреш тайм

Параметр	Величина	Единица измерения
Напряжение	220-240	В
Частота тока	50	Гц
Максимальная мощность	16	Вт
Производительность	167	м ³ /ч
	98,363	CFM
	46,426	л/с
	0,04643	м ³ /с
	2788,9	л/м
Ток	0.1	А
Частота вращения	2400	мин ⁻¹
Уровень шума на расстоянии 3 м	34	дБ(А)
Вес	0.74	кг
Защита	IP 34	класс
Размер патрубка	125	мм



Модификации

Вентс 125 ЛД Фреш тайм						
ВЕНТС 125 ЛД Фреш тайм К						
ВЕНТС 125 ЛД Фреш тайм К Л						
ВЕНТС 125 ЛД Фреш тайм Л						
ВЕНТС 125 ЛДТ Фреш тайм К Л						
ВЕНТС 125 ЛДТН Фреш тайм К						
ВЕНТС 125 ЛДВ Фреш тайм						
ВЕНТС 125 ЛДВ Фреш тайм К						
ВЕНТС 125 ЛДВ Фреш тайм К Л						
ВЕНТС 125 ЛДВ Фреш тайм Л						
ВЕНТС 125 ЛДВТ Фреш тайм						
ВЕНТС 125 ЛДВТ Фреш тайм К						
ВЕНТС 125 ЛДВТ Фреш тайм К Л						
ВЕНТС 125 ЛДВТ Фреш тайм Л						
ВЕНТС 125 ЛДВТН Фреш тайм						
ВЕНТС 125 ЛДВТН Фреш тайм К						
ВЕНТС 125 ЛДВТН Фреш тайм К Л						
ВЕНТС 125 ЛДВТН Фреш тайм Л						
ВЕНТС 125 ЛДТ Фреш тайм						
ВЕНТС 125 ЛДТ Фреш тайм К						
ВЕНТС 125 ЛДТ Фреш тайм Л						
ВЕНТС 125 ЛДТН Фреш тайм						
ВЕНТС 125 ЛДТН Фреш тайм К Л						
ВЕНТС 125 ЛДТН Фреш тайм Л						

-  Таймер
-  Обратный клапан
-  Двигатель на шарикоподшипниках
-  Шнурковый выключатель
-  Двигатели повышенной мощности
-  Датчик влажности
-  Высокое давление
-  Датчик движения
-  Безопасный (12 В)
-  Двигатель с повышенной производительностью

Габаритные размеры

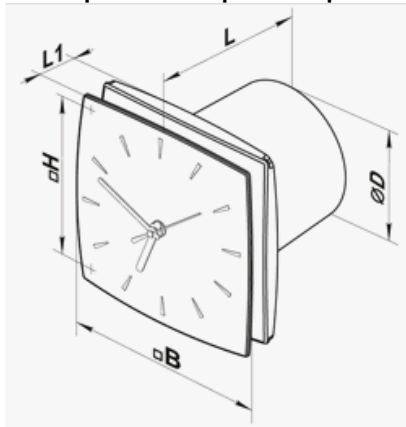

Размеры	ØD	B	H	L	L1
мм	125	175	140	145	44