

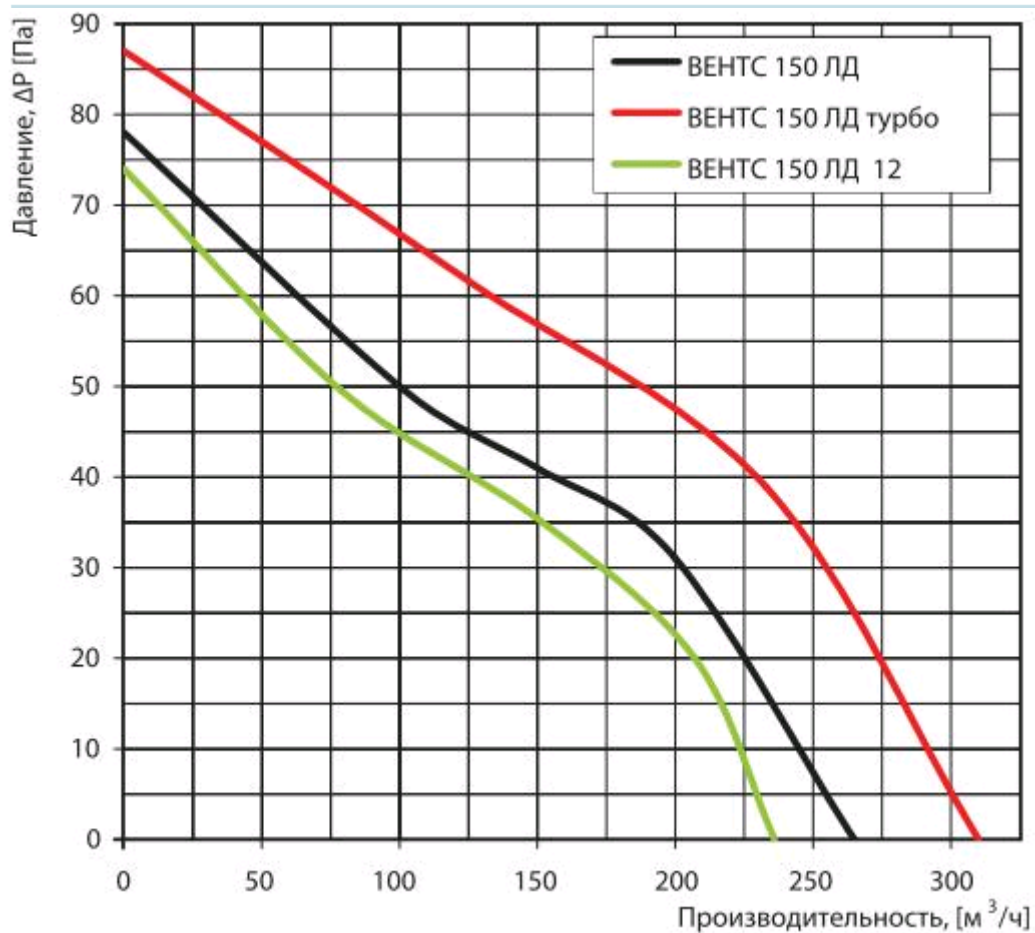





































































Технические характеристики ВЕНТС 150 ЛД

Параметр	Величина	Единица измерения
Напряжение	220-240	В
Частота тока	50	Гц
Максимальная мощность	24	Вт
Производительность	265	м ³ /ч
	156,085	CFM
	73,67	л/с
	0,07367	м ³ /с
	4425,5	л/м
Ток	0.13	А
Частота вращения	2400	мин ⁻¹
Уровень шума на расстоянии 3 м	37	дБ(А)
Вес	0.96	кг
Защита	IP 34	класс
Размер патрубка	150	мм



Модификации

Вентс 150 ЛД									
Вентс 150 ЛД К									
Вентс 150 ЛД К Л									
Вентс 150 ЛД Л									
Вентс 150 ЛДВ									
Вентс 150 ЛДВ К									
Вентс 150 ЛДВ К Л									
Вентс 150 ЛДВ Л									
Вентс 150 ЛДВТ									
Вентс 150 ЛДВТ К									
Вентс 150 ЛДВТ К Л									
Вентс 150 ЛДВТ Л									
Вентс 150 ЛДВТН									
Вентс 150 ЛДВТН К									
Вентс 150 ЛДВТН К Л									
Вентс 150 ЛДВТН Л									
Вентс 150 ЛДТ									
Вентс 150 ЛДТ К									
Вентс 150 ЛДТ К Л									
Вентс 150 ЛДТ Л									
Вентс 150 ЛДТН									
Вентс 150 ЛДТН К									
Вентс 150 ЛДТН К Л									
Вентс 150 ЛДТН Л									

-  Таймер
-  Обратный клапан
-  Двигатель на шарикоподшипниках
-  Шнурковый выключатель
-  Двигатели повышенной мощности
-  Датчик влажности
-  Высокое давление
-  Датчик движения
-  Безопасный (12 В)
-  Двигатель с повышенной производительностью

Габаритные размеры

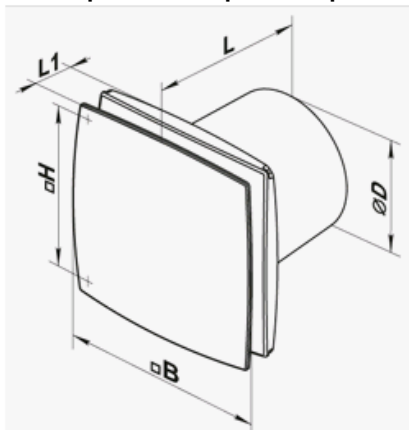

Размеры	ØD	B	H	L	L1
мм	150	206	165	154	36